

510-M

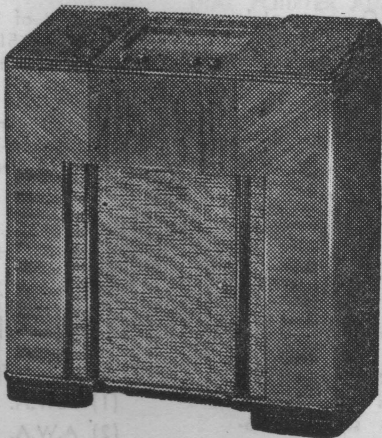

712-C

(715-C not illustrated)



801-G

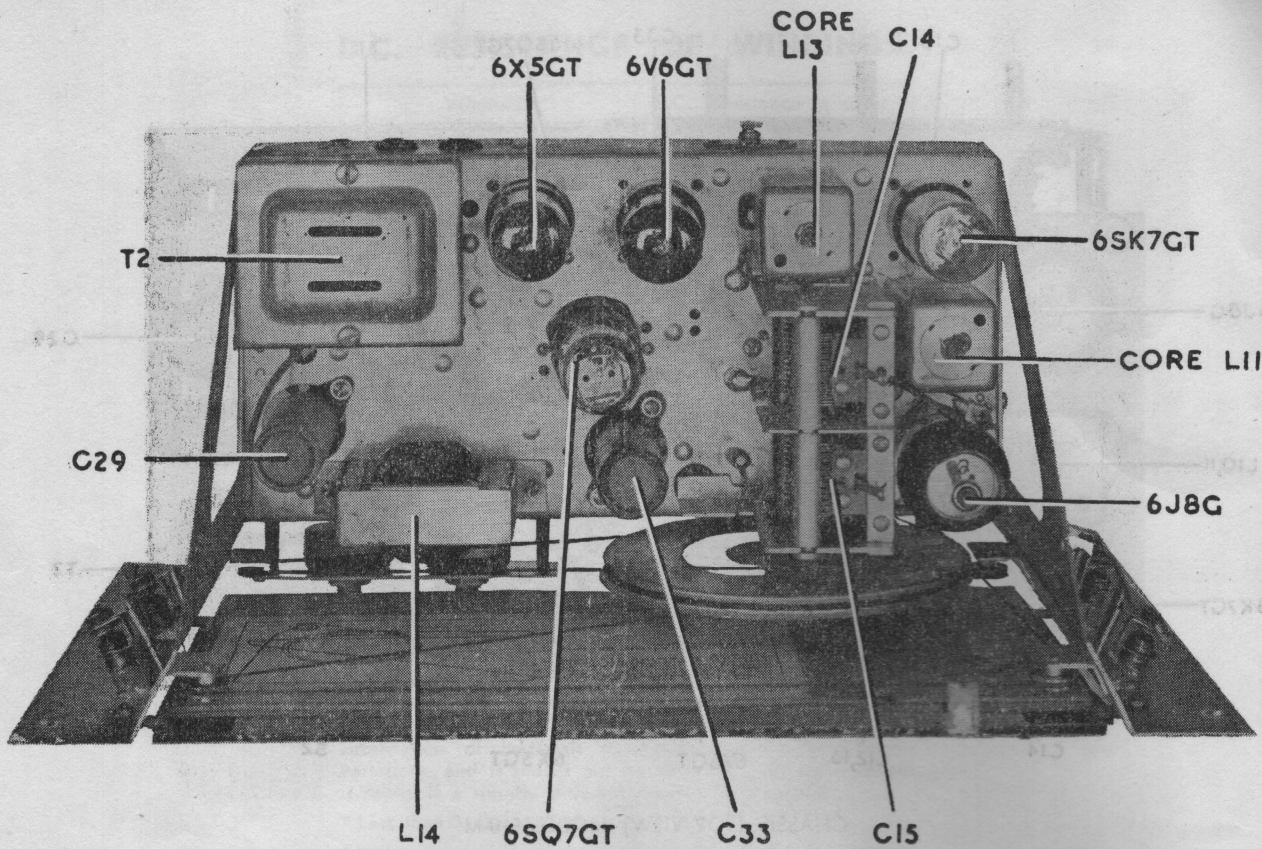

CHASSIS (TOP VIEW) MODELS 712-C and 715-C

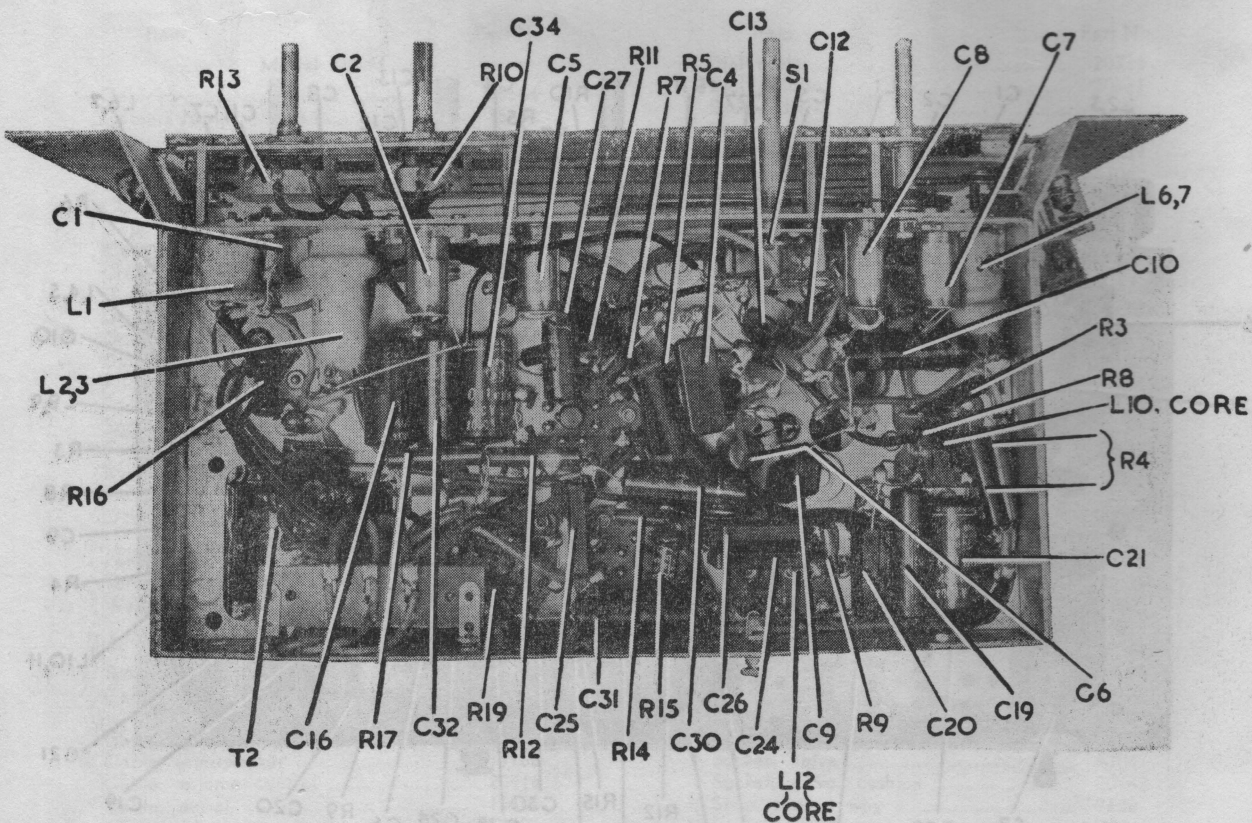

CHASSIS (UNDERNEATH VIEW) MODELS 712-C and 715-C

TECHNICAL INFORMATION AND SERVICE DATA



Models 510-M, 712-C, 715-C & 801-G

FIVE VALVE, TWO BAND, A.C. OPERATED SUPERHETERODYNES

ISSUED BY AMALGAMATED WIRELESS (A/SIA.) LTD.

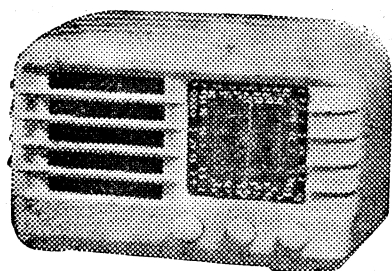

510-M

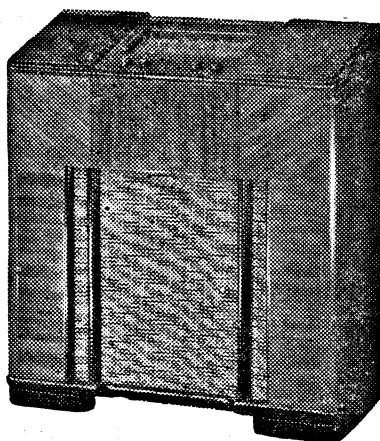

712-C

(715-C not illustrated)

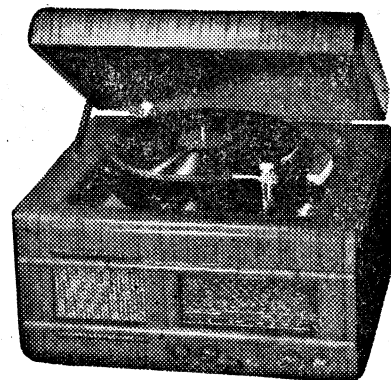

801-G

ELECTRICAL SPECIFICATIONS.

FREQUENCY RANGES:

Medium Wave 1600-540 Kc/s (187.5-555 M.) Short Wave 18-6 Mc/s (16-50 M.)

INTERMEDIATE FREQUENCY 455 Kc/s

POWER SUPPLY RATING 200-260 volts, 50-60 C.P.S.
(Models are produced with other voltage and frequency ratings.)

POWER CONSUMPTION 60 watts

DIAL LAMPS 6.3 volts, 0.25 amp. M.E.S.

VALVE COMPLEMENT:

- (1) 6J8G Converter.
- (2) 6SK7GT I.F. Amplifier.
- (3) 6SQ7GT Det., A.V.C. and A.F. Amplifier.
- (4) 6V6GT Output.
- (5) 6X5GT Rectifier.

LOUDSPEAKER:

Model 510-M.

5 inch—code No. AA16.
Transformer—XA2.
V.C. Impedance—3 ohms at 400 C.P.S.
Field—1000 ohms.

Models 712-C, 715-C.

12 inch—code No. AU42.
Transformer—TU2.
V.C. Impedance—2.2 ohms at 400 C.P.S.
Permanent Magnet.

Model 801-G.

7 inch—code No. AY28 or AY38.
Transformer—XA2.
V.C. Impedance—3 ohms at 400 C.P.S.
Permanent Magnet.

CONTROLS:

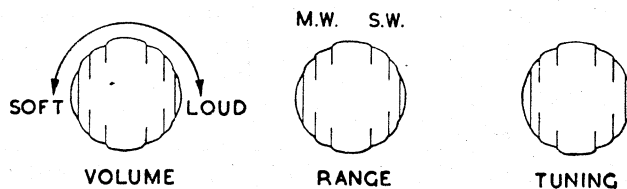

MODEL 510-M

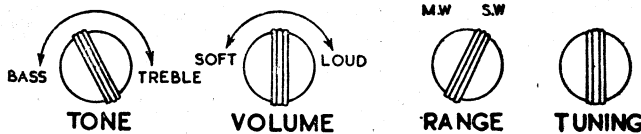

MODEL 712-C

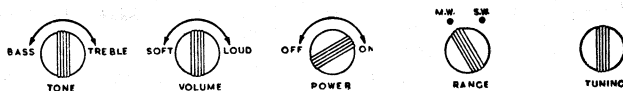

MODEL 715-C

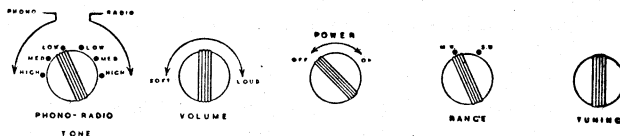

MODEL 801-G

UNDISTORTED POWER OUTPUT 3 watts

MECHANICAL SPECIFICATIONS.

	Height.	Width.	Depth.
Cabinet Dimensions (inches)—			
510-M	8	12½	7½
712-C, 715-C	32	30	13
801-G	13½	20¼	16¾
Chassis Base Dimensions (inches) ..			
	2½	11	5½

	Height.	Width.	Depth.
Carton Dimensions (inches)—			
510-M	10½	13¾	8¾
712-C, 715-C	33	31¾	14¾
801-G	14½	21½	18¾
Weight (nett lbs.)—			
510-M			14
712-C, 715-C			56
801-G			

GENERAL DESCRIPTION.

The models 510-M, 712-C, 715-C and 801-G are mantel, console, console, and table Radio-Phonograph Combination models respectively.

The 510-M is housed in an attractively designed moulded cabinet which is produced in three colours—ivory, green, and walnut. Features of design include:—Tropic-proof construction, automatic volume control, magnetite cores in I.F. transformers and broadcast oscillator coil, air-dielectric trimming capacitors.

Features of the 712-C, 715-C and 801-G are similar to those of the 510-M but use a straight-line edge lighted dial with metropolitan stations printed in ⅛" high characters.

In addition the 801-G incorporates the Oak automatic record changer, features of this being:—New type crystal pick-up head—Permapoint needle plays .000 records, uses 10" or 12" records, manual or automatic operation as required.

Synchronous motor and simple construction with minimum of working parts ensures trouble-free service.

ALIGNMENT PROCEDURE.

MANUFACTURER'S SETTING OF ADJUSTMENTS.

The receiver is tested by the manufacturers with precision instruments, and all adjusting screws are sealed. Re-alignment should be necessary only when components in tuned circuits are repaired or replaced, or when it is found that the seals over the adjusting screws have been broken.

It is especially important that the adjustments should not be altered unless in association with the correct testing instruments listed below.

For all alignment operations, connect the "low" side of the signal generator to the receiver chassis, and keep the generator output as low as possible to avoid A.V.C. action. Also, keep the volume control in the maximum clockwise position.

TESTING INSTRUMENTS.

- (1) A.W.A. Junior Signal Generator, type 2R3911 or
- (2) A.W.A. Modulated Oscillator, type J6726.

If the modulated oscillator is used, connect an 0.25 megohm non-inductive resistor across the output terminals, and, for short-wave alignment, an additional 400 ohms non-inductive resistor in series with the "high" output lead of the instrument.

- (3) Output Meter.

The instrument recommended should have an output impedance of 5000 ohms and a range of 5-3000 milliwatts. The meter should be connected across the primary of the loudspeaker transformer with the voice-coil of the loudspeaker open-circuit.

ALIGNMENT TABLE.

Order.	Connect "high" side of Generator to:	Tune Generator to:	Tune Receiver Dial to:	Adjust for maximum peak output.
1	6J8G*	455 kc/s	540 kc/s	L13 core
2	6J8G*	455 kc/s	540 kc/s	L12 core
3	6J8G*	455 kc/s	540 kc/s	L11 core
4	6J8G*	455 kc/s	540 kc/s	L10 core
Repeat the above adjustments until the maximum output is obtained.				
5	Aerial terminal	600 kc/s	600 kc/s	L.F. osc. core adj. (L7) †
6	Aerial terminal	1500 kc/s	1500 kc/s	H.F. osc. adj.**
7	Aerial terminal	1500 kc/s	1500 kc/s	H.F. osc. adj. (C2)
Repeat adjustments 5, 6 and 7.				
8	Aerial terminal	16 Mc/s	16 Mc/s	H.F. osc. adj. ‡ o
9	Aerial terminal	16 Mc/s	16 Mc/s	H.F. aer. adj. § oo

* With grid clip connected. An 0.001 uF capacitor should be connected in series with the "high" side of the test instrument.

† Rock the tuning control back and forth through the signal.

‡ Use minimum capacity peak if two can be obtained. Check to determine that the trimmer has been adjusted to correct peak by tuning the receiver to approximately 15.09 Mc/s, where a weaker signal should be received.

§ Use minimum capacity peak if two can be obtained.

** C7 in models 510-M, 712-C, and 715-C; C8 in model 801-G.

o C8 in models 510-M, 712-C and 715-C; C9 in model 801-G.

oo C5 in models 510-M, 712-C and 715-C; C6 in model 801-G.

LOUDSPEAKER SERVICE.

It is inadvisable to attempt loudspeaker repairs other than replacement of the transformer. The fitting of a new cone or the replacement of a field winding should be done only by service departments suitably equipped to do the work.

CONNECTION TO POWER SUPPLY.

The receiver should not be connected to any circuit supplying other than alternating current from 200-260 volts and at the frequency stated on the label within the cabinet. The power supply connections are shown in the accompanying diagrams.

RED DOT INDICATES COMMON CONNECTION FOR ALL VOLTAGES

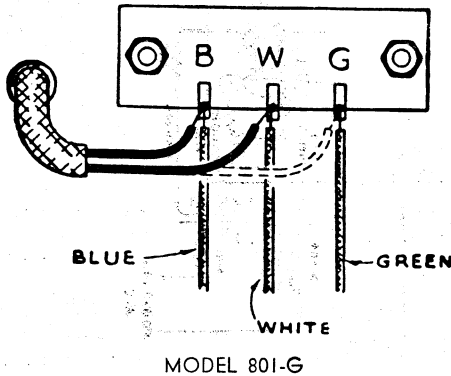
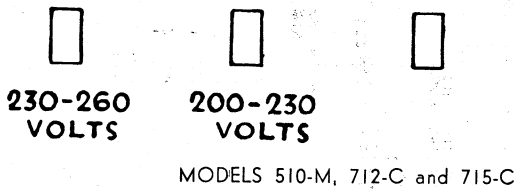

CHASSIS REMOVAL.

Model 510-M.

First remove the knobs and felt washers—each knob is held by a set screw. Then, remove two screws from underneath the cabinet and withdraw the chassis.

Model 712-C, 715-C.

- (1) Remove the knobs and felt washers. The knobs are each held by a set screw.

- (2) Disconnect loudspeaker cable.
- (3) The chassis is held in the cabinet by four winged nuts, two at each end of the dial frame assembly.

Model 801-G.

The chassis is removed through the base of the cabinet as follows:—

- (1) Remove the knobs and felt washers.
- (2) Disconnect the pick-up and loudspeaker cable and remove the Phono-motor connection plug from the socket on the chassis.
- (3) Remove four screws from the bottom of the cabinet and withdraw chassis and board. The baseboard is fastened to the chassis by two screws.

DIAL POINTER ADJUSTMENT.

Model 510-M.

To shift the position of the dial pointer, loosen two screws in the rear of the drive drum—see accompanying diagram—move the pointer disc to the required position and re-tighten the screws.

Models 712-C, 715-C and 801-G.

The dial pointer is held in position on the drive cord by two rubber lined clips. To alter the position of the pointer loosen the holding clips slightly, and move the pointer in the required direction. It is important to re-clip the clips after any adjustment of the dial pointer.

To replace the Tuning Drive Cord, follow the diagram which is affixed to the back of the Dial Frame Assembly. This shows the route of the cord and the method of attachment.

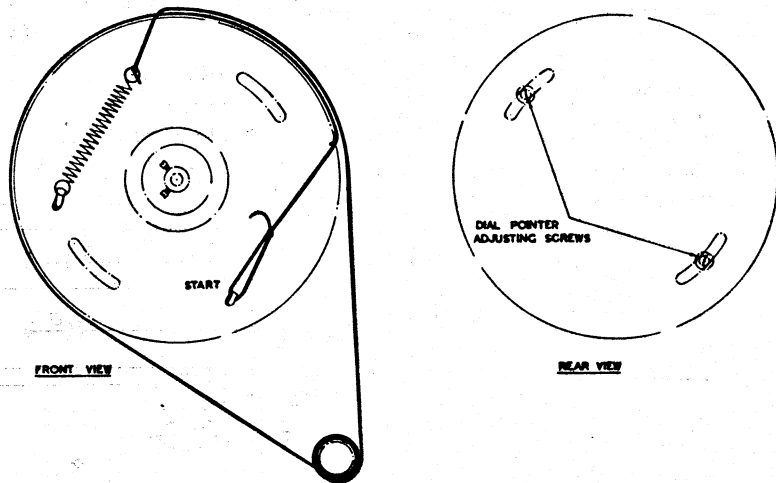

SOCKET VOLTAGES

Valves.	Cathode to Chassis. Volts.	Screen Grid to Chassis. Volts.	Anode to Chassis. Volts.	Anode Current mA.	Heater Volts.
6J8G Converter, M.W.	1.5	70	240	1	6.3
S.W.	2.0	70	240	1.3	—
Oscillator, M.W.	—	—	115	5	—
S.W.	—	—	115	5	—
6SK7GT I.F. Amplifier	0	70	240	5	6.3
6SQ7GT 2nd Det., A.V.C. and A.F. Amplifier	0	—	90*	0.6	6.3
6V6GT Output	13	240	225	40	6.3
6X5GT Rectifier	300	—	280 (AC)	—	6.3

Volts across back-bias resistor R16 (510, 712 and 715), R18 (801-G)—3.0.

Total H.T. current—60 mA.

Measured at 240 volts A.C. supply. No signal input. Volume Control maximum clockwise. Voltmeter, 1000 ohms per volt, measurements taken on highest scale giving accurate readable deflection.

*This reading may vary depending on the resistance of the voltmeter used.

CIRCUIT DIAGRAM—Models 712-C & 715-C

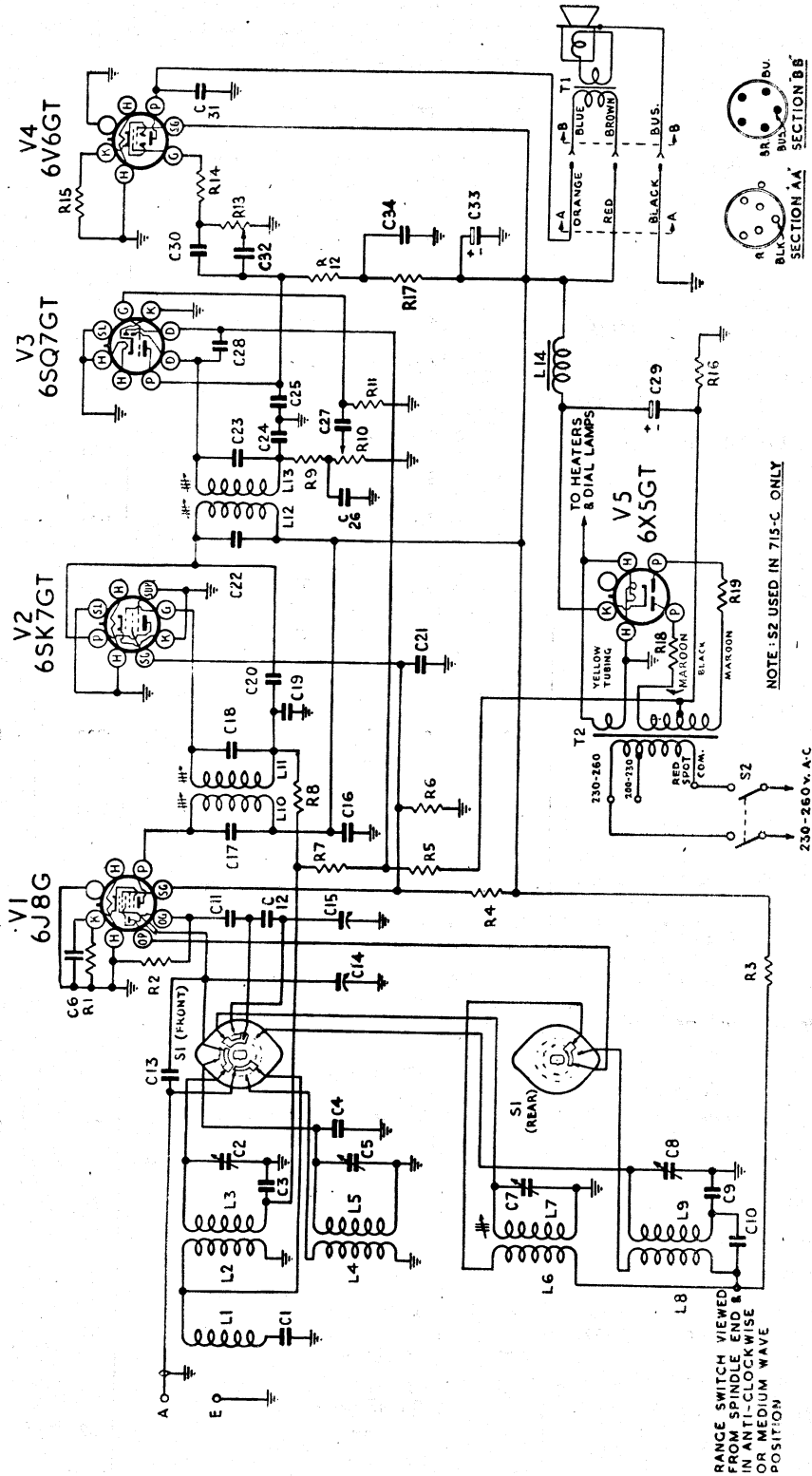

CIRCUIT DIAGRAM—Model 510-M

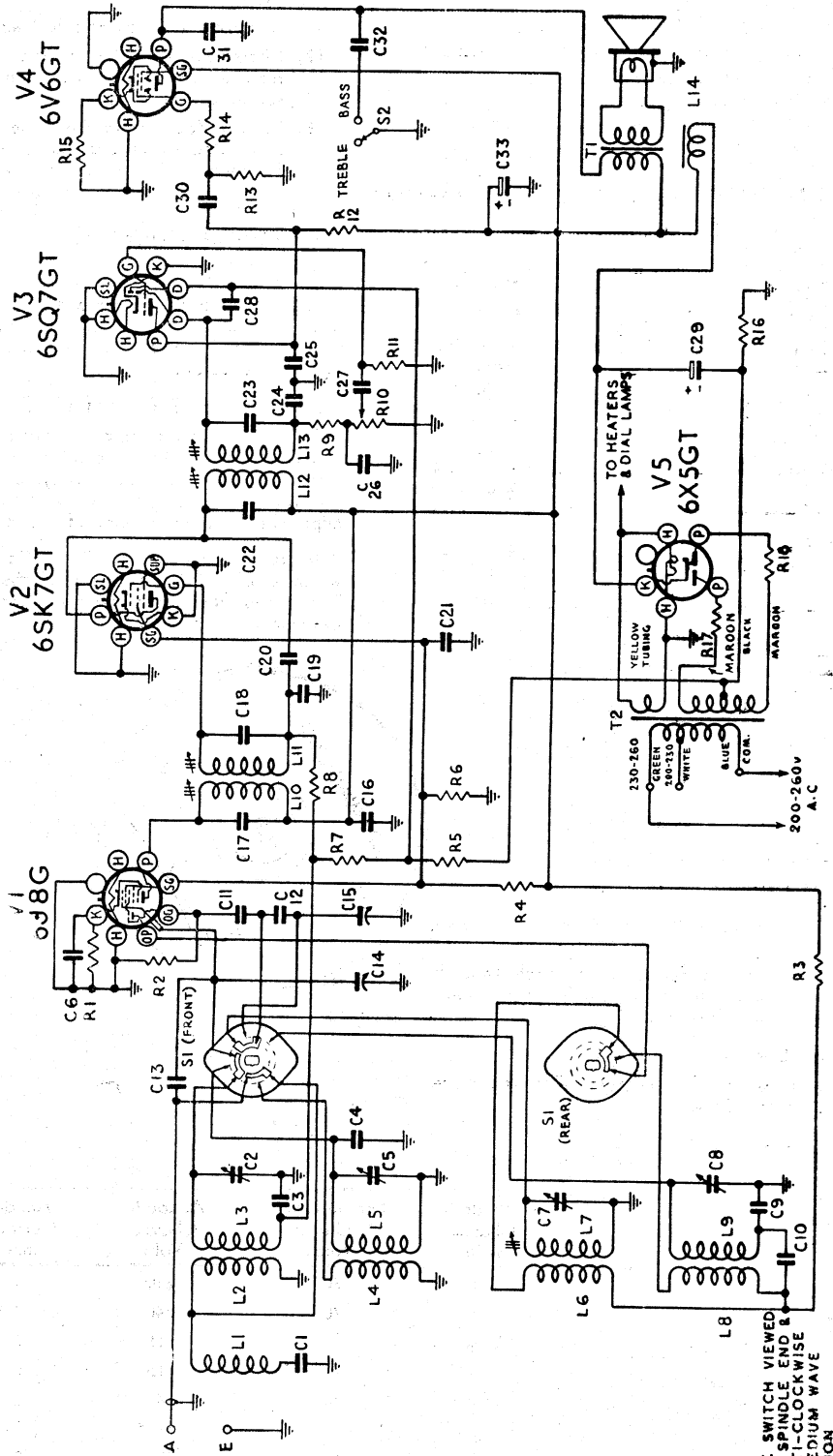

RANGE SWITCH VIEWED FROM SPINDLE END & IN ANTI-CLOCKWISE OR MEDIUM WAVE POSITION

CIRCUIT DIAGRAM AND CODE--Model 801-G

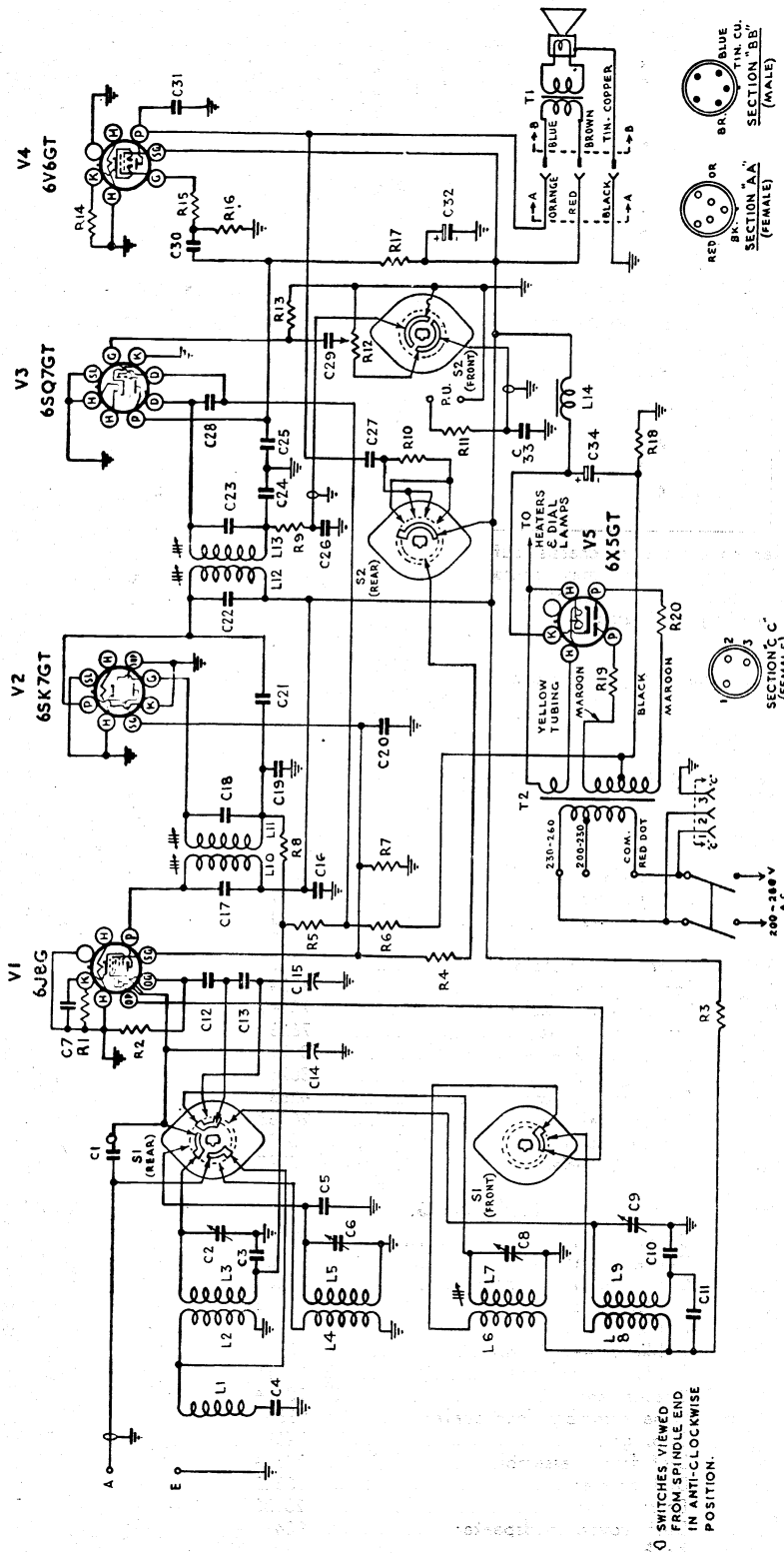

Circuit Code No.	Description.	Stock Code or Part No.	Circuit Code No.	Description.	Stock Code or Part No.	Circuit Code No.	Description	Stock Code or Part No.
L1	I.F. filter (including C4)	9382	C11	.05 uF paper, 400 v.		C29	.01 uF paper, 600 v.	
L2, L3	Aerial coil, 540-1600 Kc/s	15454	C12	working		C30	.02 uF paper, 600 v.	
L4, L5	Aerial coil, 6-18 Mc/s	15456	C13	470 uF mica paddler		C31	working	
L6, L7	Oscillator coil, 540-1600 Kc/s	9206A	C14	12-430 uF tuning (ganged)	18211	C32	.01 uF paper, 600 v.	
L8, L9	Oscillator coil, 6-18 Mc/s	15458	C15	12-430 uF tuning (ganged)	18211	C33	lytic	
L10, L11	1st I.F. transformer (17640)*	17646	C16	0.1 uF paper, 400 v.		C34	500 uF mica	
L12, L13	2nd I.F. transformer (17640)*	17646	C17	70 uF mica		T1	8 uF 525 P.V. electrolytic	
L14	Filter choke	TU17	C18	70 uF mica		T2	TRANSFORMERS.	
R1	200 ohms, 1/2 watt		C19	.02 uF paper, 600 v.		T1	Loudspeaker transformer	XA2
R2	32,000 ohms, 1/2 watt		C20	working		T2	Power transformer, 50-60 C.P.S.	17859
R3	25,000 ohms, 1 watt		C21	14 uF mica		T2	Power transformer, 40 C.P.S.	17861
R4	25,000 ohms, 2 watt		C22	70 uF mica		S1	SWITCHES.	
R5	1.6 megohms, 1/2 watt		C23	70 uF mica		S1	Range switch, 1 wafer, 2 position rotary	20507
R6	2.5 megohms, 1/2 watt		C24	100 uF mica		S2	Phono/radio/tones switch, 1 wafer, 6 position, rotary	20509
R7	20,000 ohms, 1 watt		C25	200 uF mica		S3	D.P.S.T	20052
R8	0.1 megohms, 1/2 watt		C26	100 uF mica				
R9	50,000 ohms, 1/2 watt		C27	.035 uF paper, 600 v.				
R10	8,000 ohms, 1/2 watt		C28	50 uF mica				

* Part number of winding only.

CIRCUIT CODE—Models 510-M, 712-C & 715-C

Circuit Code No.	Description.	Stock Code or Part No.	Circuit Code No.	Description.	Stock Code or Part No.	Circuit Code No.	Description.	Stock Code of Part No.
INDUCTORS.			R17	50,000 ohms, 1 watt (712-C, 715-C only)		C24	100 uuF mica	
L1	I.F. filter (including C1)	9382		(712-C, 715-C)		C25	200 uuF mica	
L2, L3	Aerial coil, 540-1600 kc/s	15454	R18	100 ohms, ½ watt		C26	100 uuF mica	
L4, L5	Aerial coil, 6-18 Mc/s	15456	R19	100 ohms, ½ watt (712-C, 715-C only)		C27	0.01 uF paper, 600 v. working	
L6, L7	Oscillator coil, 540-1600 kc/s	9206A	CAPACITORS.			C28	50 uuF mica	
L8, L9	Oscillator coil, 6-18 Mc/s	15458	C1	50 uuF silvered mica		C29	8 uF, 525 P.V. electrolytic	
L10, L11	1st I.F. transformer (17640)*	17646	C2	3-25 uuF air trimmer	19659	C30	0.02 uF paper, 600 v. working (510-M only)	
L12, L13	2nd I.F. transformer (17640)*	17646	C3	0.05 uF paper, 200 v. working	15422	C30	0.01 uF paper, 600 v. working (712-C, 715-C only)	
L14	Loudspeaker field, 1000 ohms (510-M)		C4	9 uuF mica		C31	0.01 uF paper, 600 v. working (510-M only)	
L14	Filter choke, 1000 ohms (712-C)	TU17	C5	3-25 uuF air trimmer	19659	C31	0.005 uF paper, 600 v. working (712-C, 715-C only)	
RESISTORS.			C6	0.1 uF paper, 200 v. working		C32	0.03 uF paper, 600 v. working (510-M only)	
R1	200 ohms, ½ watt		C7	3-25 uuF air trimmer	19659	C32	0.005 uF paper, 600 v. working (712-C, 715-C only)	
R2	32,000 ohms, ½ watt		C8	3-25 uuF air trimmer	19659	C33	16 uF, 525 P.V. electrolytic	
R3	25,000 ohms, 1 watt		C9	4000 uuF mica (S.W. padder)		C34	0.1 uF paper, 400 v. working (712-C, 715-C only)	
R4	25,000 ohms, 2 watt		C10	0.05 uF paper, 400 v. working		TRANSFORMERS.		
R5	2.5 megohms, ½ watt		C11	70 uuF mica		T1	Loudspeaker Transformer (510-M)	XA2
R6	20,000 ohms, 1 watt		C12	470 uuF mica (M.W. padder)		T1	Loudspeaker Transformer (712-C, 715-C)	TU2
R7	1.6 megohms, ½ watt		C13	4 uuF mica		T2	Power, 50-60 C.P.S.	17859B
R8	0.1 megohm, ½ watt		C14	12-430 uuF variable, tuning (ganged)	18201	T2	Power, 40 C.P.S.	17861B
R9	50,000 ohms, ½ watt		C15	12-430 uuF, variable, tuning (ganged)	18201	SWITCHES.		
R10	0.5 megohm, volume control (510-M only)	6491	C16	0.1 uF paper, 400 v. working		S1	Range, single wafer, 4 pole, 2 position rotary (510-M)	20156
R10	0.5 megohm, volume control (712-C, 715-C only)	7927	C17	70 uuF mica		S1	Range, single wafer, 4 pole, 2 position rotary (712-C, 715-C)	20354
R11	10 megohms, 1 watt		C18	70 uuF mica		S2	Tone, S.P.S.T., toggle (510-M)	20109
R12	0.2 megohm, 1 watt		C19	0.02 uF paper, 600 v. working		S2	Power, D.P.S.T. Rotary (715-C)	20052
R13	0.5 megohm, ½ watt (510-M only)		C20	14 uuF mica				
R13	0.5 megohm, tone control (712-C, 715-C only)	7927	C21	0.1 uF paper, 400 v. working				
R14	40,000 ohms, ½ watt		C22	70 uuF mica				
R15	325 ohms, 3 watt		C23	70 uuF mica				
R16	50 ohms, 3 watt							
R17	100 ohms, ½ watt (510-M only)							

* Part number of winding only.

D.C. RESISTANCE OF WINDINGS.

Winding.	D.C. Resistance in ohms.
Aerial Coil (M.W.)—	
Primary (L2)	30
Secondary (L3)	4
Aerial Coil (S.W.)—	
Primary (L4)	4
Secondary (L5)	*
Oscillator Coil (M.W.)—	
Primary (L6)	2
Secondary (L7)	6
Oscillator Coil (S.W.)—	
Primary (L8)	*
Secondary (L9)	*
I.F. Transformer Windings	12
I.F. Filter (L1)	17.5†
Power Transformer (T1)—	
Primary	50
Secondary	400
Loudspeaker Input Trans- former (T2)—	
XA2 Primary	450
XA2 Secondary	*
TU2 Primary	490
TU2 Secondary	*

The above readings were taken on a standard chassis, but substitution of materials during manufacture may cause variations, and it should not be assumed that a component is faulty if a slightly different reading is obtained.

* Less than 1 ohm.

† In some receivers this reading may be as high as 60 ohms.

MECHANICAL REPLACEMENT PARTS.

Item.	Part No.	Item.	Part No.
Model 510-M.			
Cabinet	20164	Dial scale	20334
Cable, Aerial	15452	Dial pointer	2033†
Cable, Power	209	Drum, drive	9090
Cable, Volume Control	15451	Knob	4589
Chassis, End	20124	Screen, I.F. transformer	17639
Clamp, Dial Scale	17720	Socket, valve	4704
Clip, Grid	7459	Socket, valve cushion	20142
Cone, Assembly, Loudspeaker	10678	Strip, tag 1 way	7628
Dial Scale	20008	2 way	8021
Dial Pointer Assembly	20132	3 way	8821
Dial Cord	20154	Strip, tag, power	4263
Drum, Drive	20130	Socket, dial lamp	20163
Dust Cover, Loudspeaker	7848	Spindle, tuning	20330
Knob (Colour to be specified)	17603	Terminal, aerial	17717
Socket, Valve	4704		
Socket, valve, cushion	20142	Model 801-G.	
Screen, I.F. transformer	17639	Cabinet	C79
Spindle, tuning	20141	Cable, loudspeaker	19188
Spring, drive tension	6641	Cable, volume control	20425
Strip, tag—1 way	7628	Cable, aerial	15452
2 way	8863	Cable, power	209
Panel, front	15448	Cable, power, 3 way	207
Terminal, aerial	17717	Cable, power, motor	21911
Washer, felt	19538	Chassis end	20124
		Cone assembly, loudspeaker	9356
		Clip, grid	7459
		Dial frame assembly	20514
		Dial pointer	20522
		Drum, drive	20130
		Dust, cover, loudspeaker	9843
		Knob	4589
		Socket, valve	4704
		Socket, valve, cushion	20142
		Strip, tag—1 way	7628
		2 way	8021
		Strip, tag, power	4263
		Screen, I.F. transformer	17639
		Terminal, aerial	5458
Model 712-C, 715-C.			
Bracket, support	20320		
Cabinet, 712-C	C78		
715-C	C81		
Cable, power	209		
Cable, loudspeaker	19188		
Cable, volume control	20416		
Cable, aerial	15452		
Clip, grid	7459		
Cone assembly, loudspeaker	7071		
Dust, cover, loudspeaker	10306		
Dial frame assembly	20343		

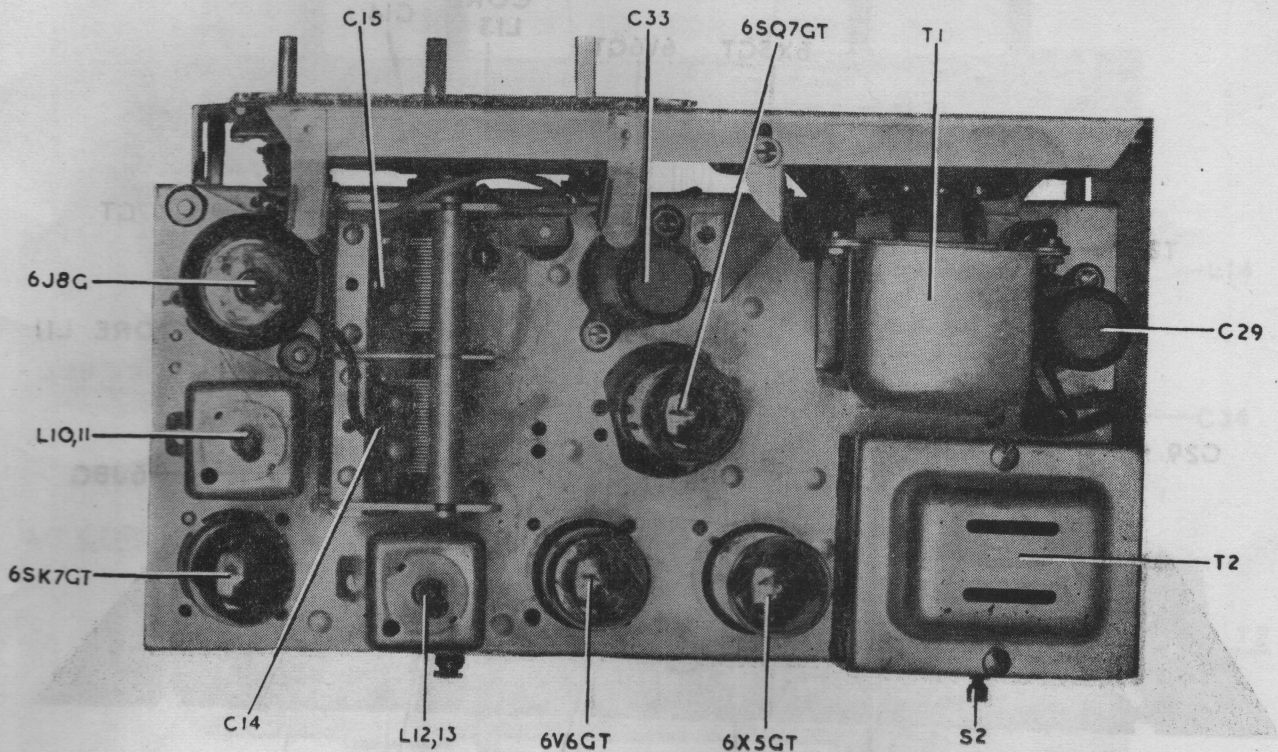

CHASSIS (TOP VIEW) MODEL 510-M

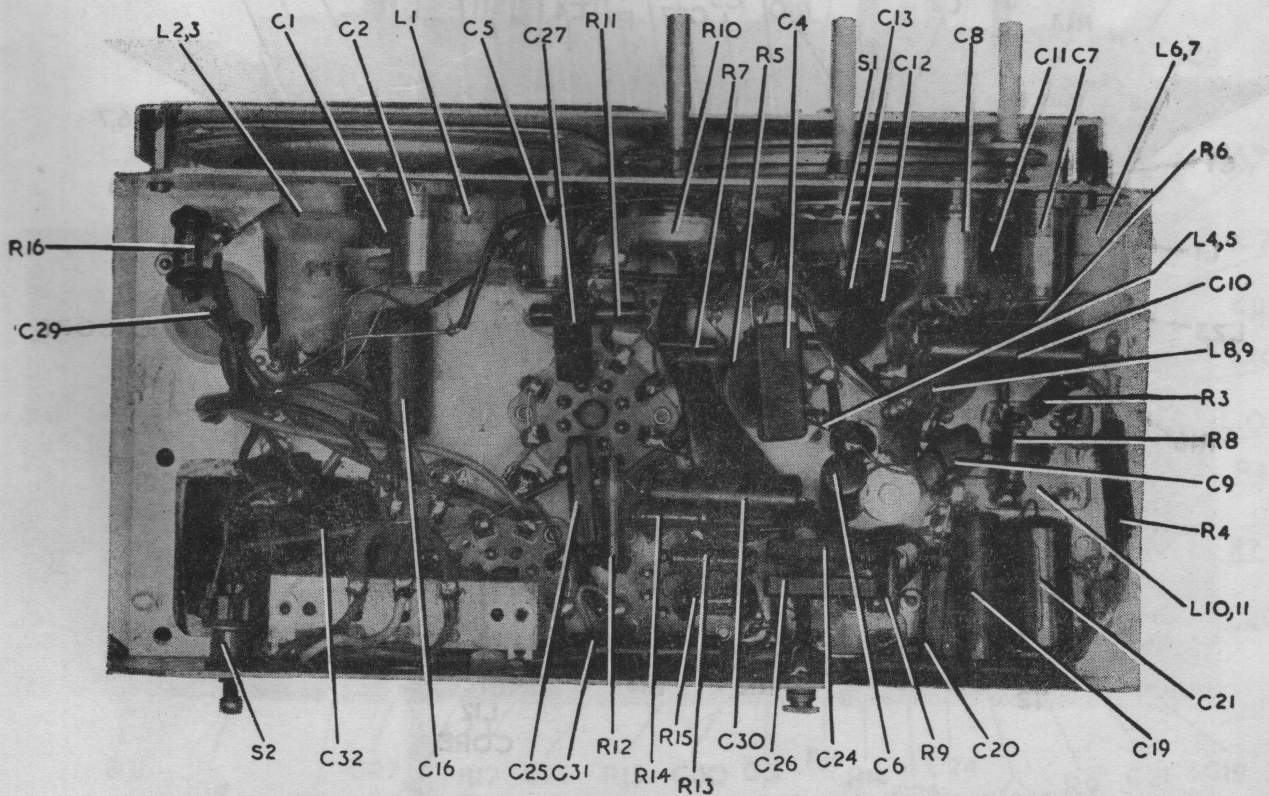

CHASSIS (UNDERNEATH VIEW) MODEL 510-M

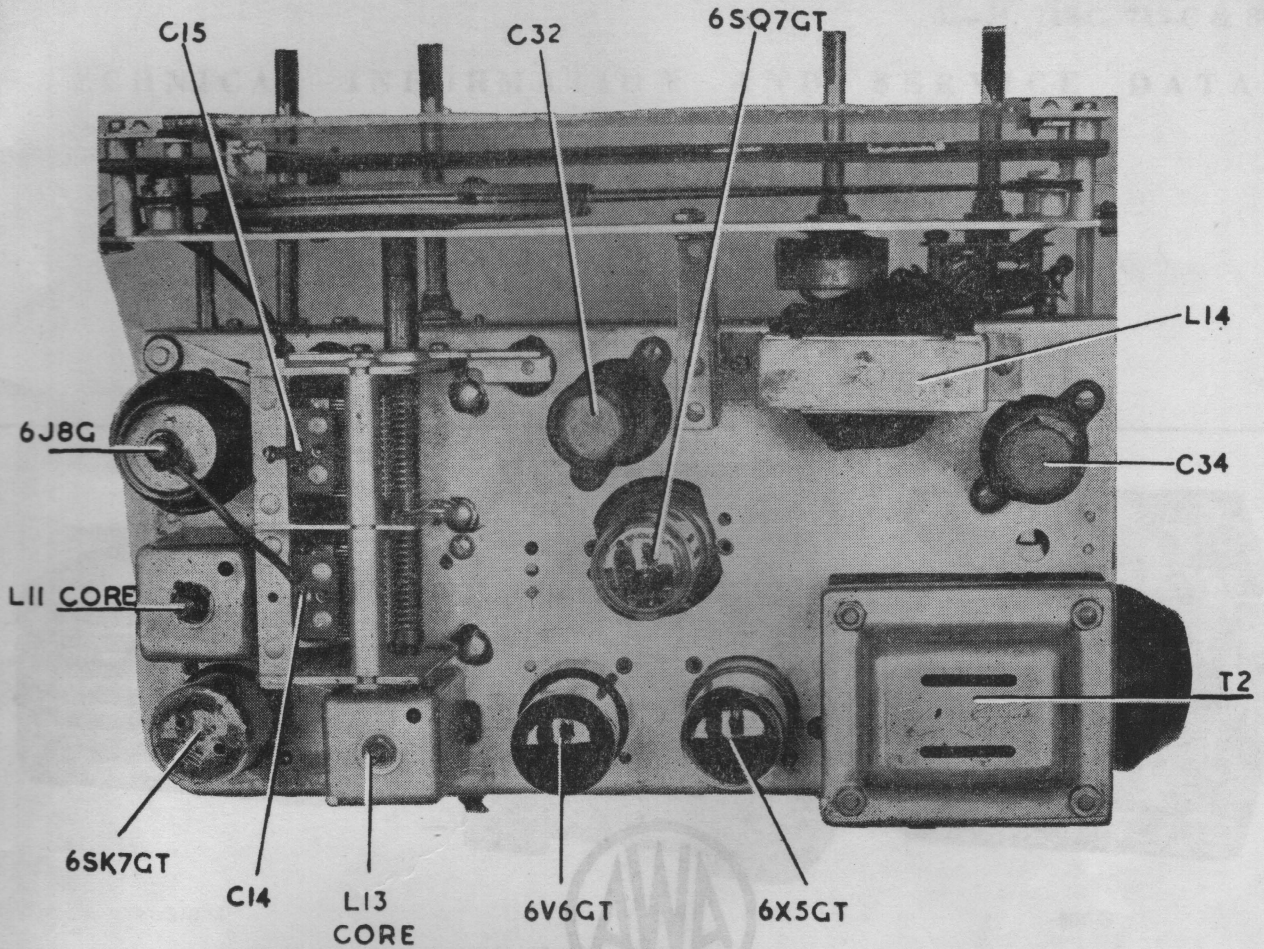

CHASSIS (TOP VIEW) MODEL 801-G

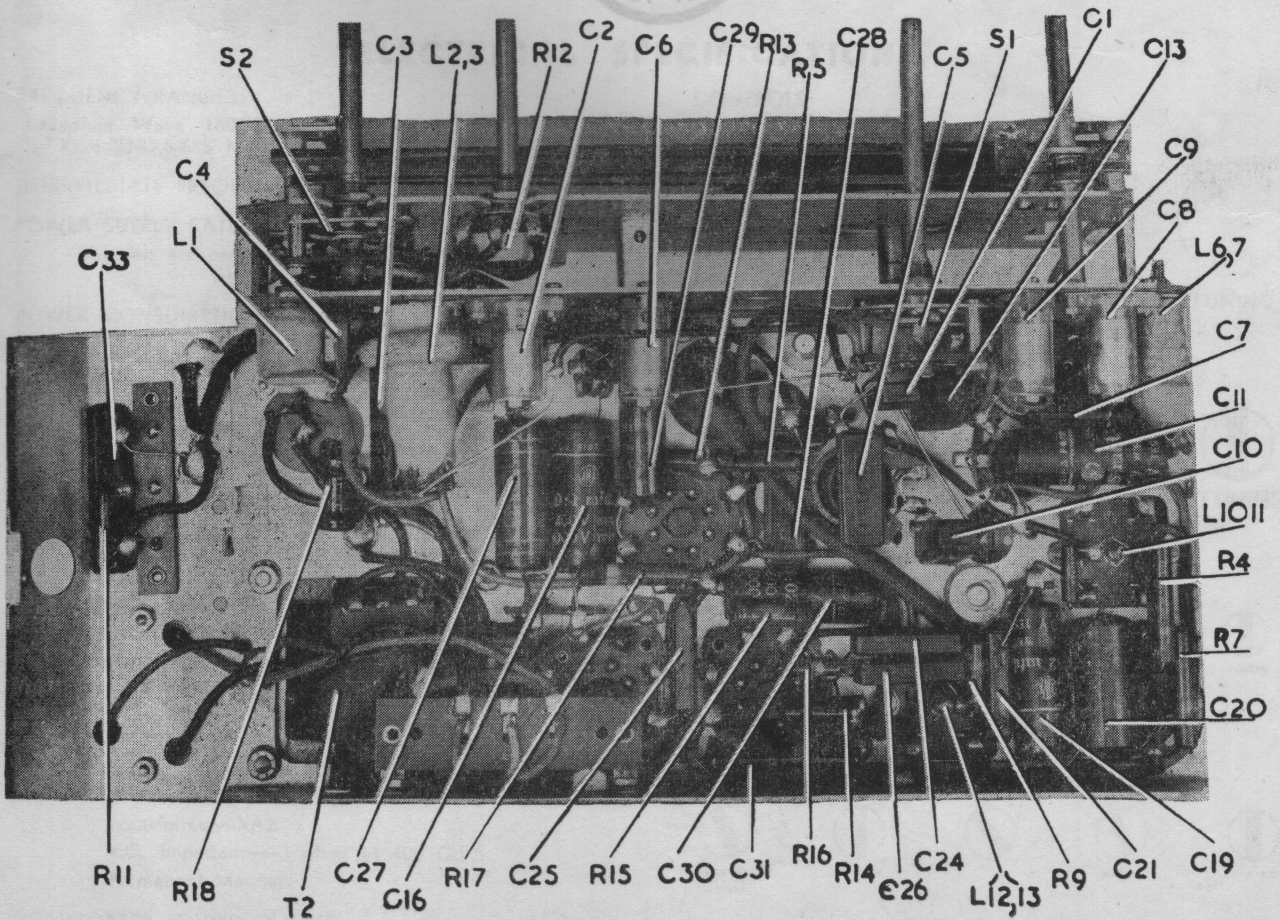

CHASSIS (UNDERNEATH VIEW) MODEL 801-G